

AEROTECH LINEAR 275 MODEL	
BLADE SPECIFICATIONS	
BLADE DESIGN	LINEAR
BLADE DIMENSIONS	275mm x 46mm x 3mm
BLADE MATERIAL	6016 EXTRUDED ALUMINIUM
BLADE FINISH	POWDER COATED
BLADE CENTRES	263mm
BLADE OPENING	217mm
GUTTER SPECIFICATIONS	
GUTTER DESIGN	SQUARE EDGE LOW-STREAMLINE
GUTTER DIMENSIONS	140mm x 40mm x 2mm
GUTTER MATERIAL	6061 EXTRUDED ALUMINIUM
GUTTER FINISH	POWDER COATED
PIVOT SPECIFICATIONS	
PIVOT TRACK	12mm x 25mm x 3mm
PIVOT TRACK MATERIAL	6061 EXTRUDED ALUMINIUM
PIVOT TRACK FINISH	POWDER COATED
DRIVE ARM SPECIFICATIONS	
DRIVE-ARM	25mm x 25mm x 3mm
DRIVE-ARM MATERIAL	6061 EXTRUDED ALUMINIUM
DRIVE-ARM FINISH	POWDER COATED
PARTS AND CONNECTOR SPECIFICATIONS	
PIN SET	8mm DIA 316 MARINE GRADE STAINLESS STEEL
SPRING SET	316 MARINE GRADE STAINLESS STEEL
CONNECTOR HOUSING	100% UV STABLE HARDENED NYLON INNER
WEATHER STRIP	PVC STORM INSERTION STRIP
MOTOR & CONTROL SPECIFICATIONS	
MOTOR TYPE	GERMAN MADE LINEAR 240V ACTUATOR
CONTROLS	HARD WIRED OR REMOTE OPERATION
SENSORS	RAIN, WIND & SUN SENSORS

AEROTECH SERIES - LINEAR 275 MODEL - OPENING LOUVRED ROOF SYSTEM

BLADES PERPENDICULAR WITH BUILDING

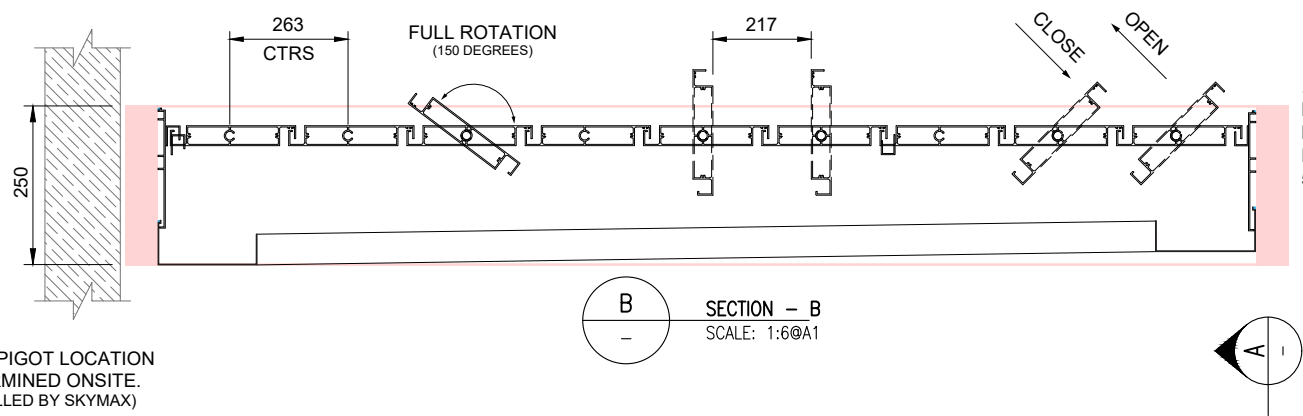

DOWNPIPE SPIGOT LOCATION TO BE DETERMINED ON SITE. (SPIGOT INSTALLED BY SKYMAX)

(LOCATED ON LOW SIDE BEST PRACTICE. DOWNPIPE & CONNECTION TO STORMWATER IS BY CLIENT)

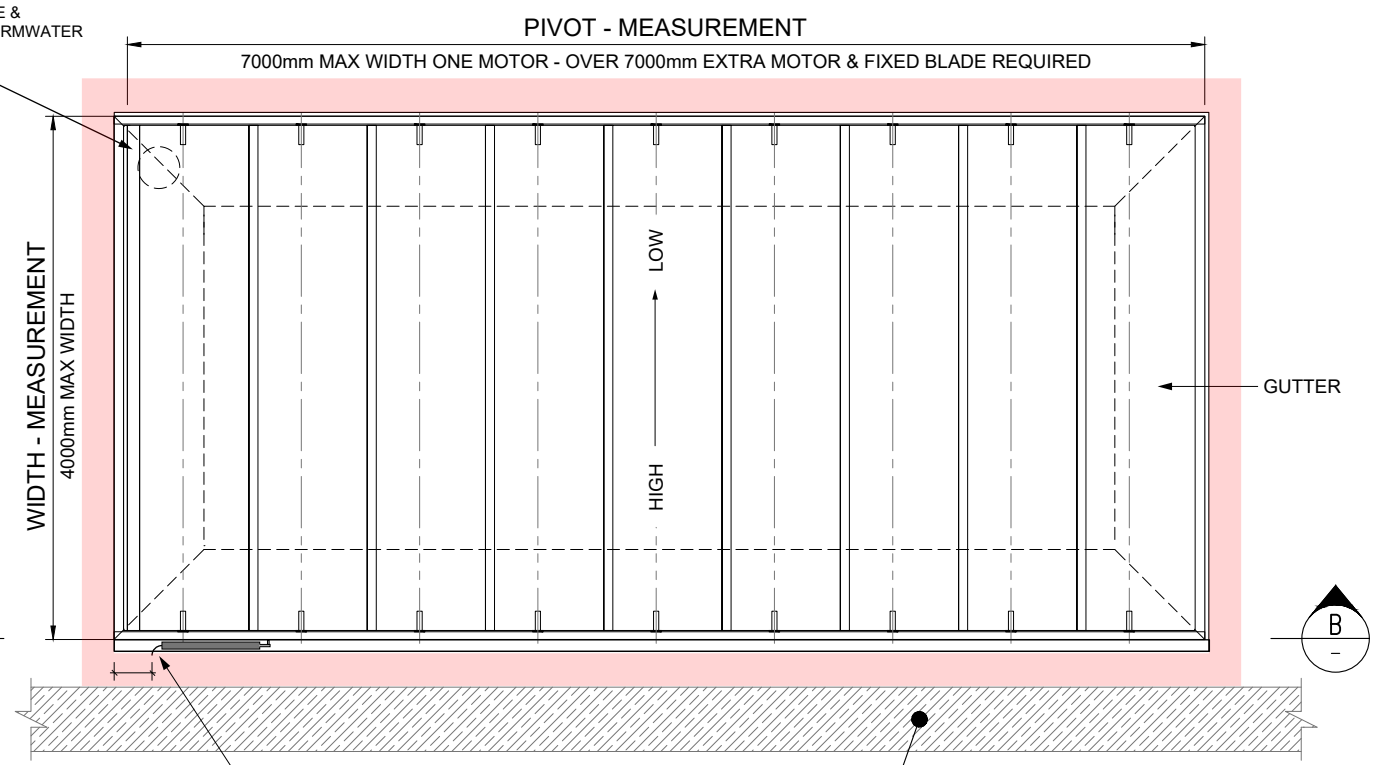

POWER LOCATED HIGH SIDE OF THE BLADE & OPPOSITE END TO BLADE OPENING. (100mm FROM INTERNAL FRAME & 30mm DOWN FROM THE TOP SIDE OF BLADE, SUPPLY OF POWER BY CLIENT)

240V ACTUATOR (LOCATED AT HIGH SIDE OF BLADE)
120mm CLEARANCE REQUIRED ABOVE FRAME

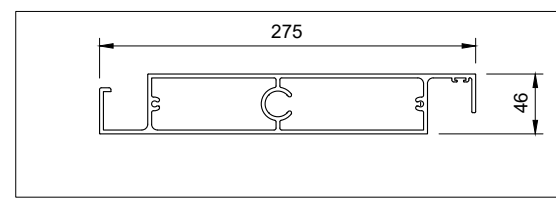
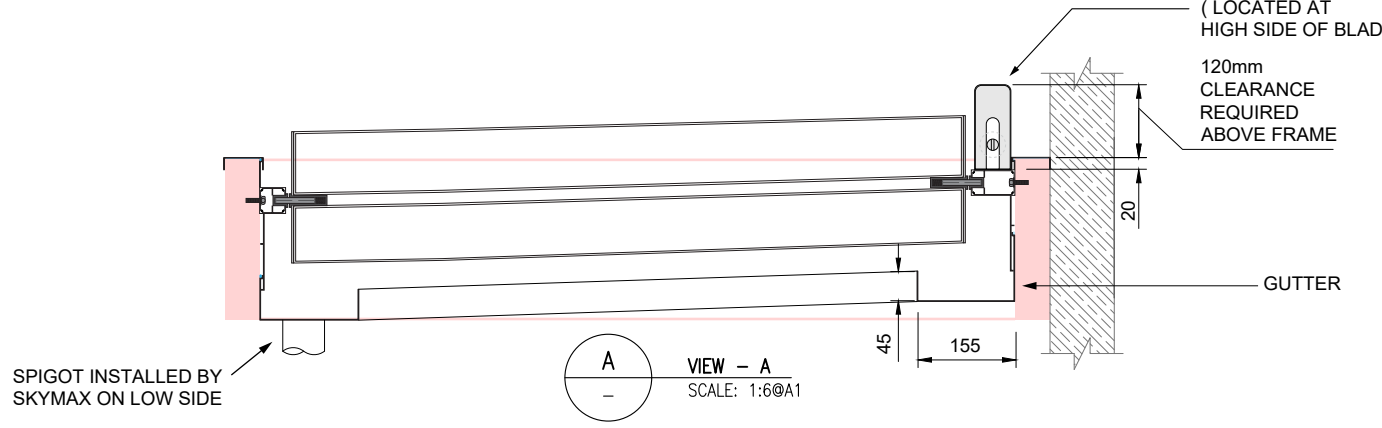

275 LOUVRE BLADE DETAIL
SCALE 1:2 @A1

LEGEND: THIS INDICATES SUPPORT FRAME BY CLIENT

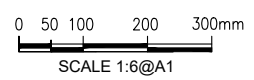

SUPPORT FRAME CONSTRUCTED BY CLIENT - DESIGN OPTIONS
(AEROTECH SYSTEM EXCLUDES SUPPORT FRAME)

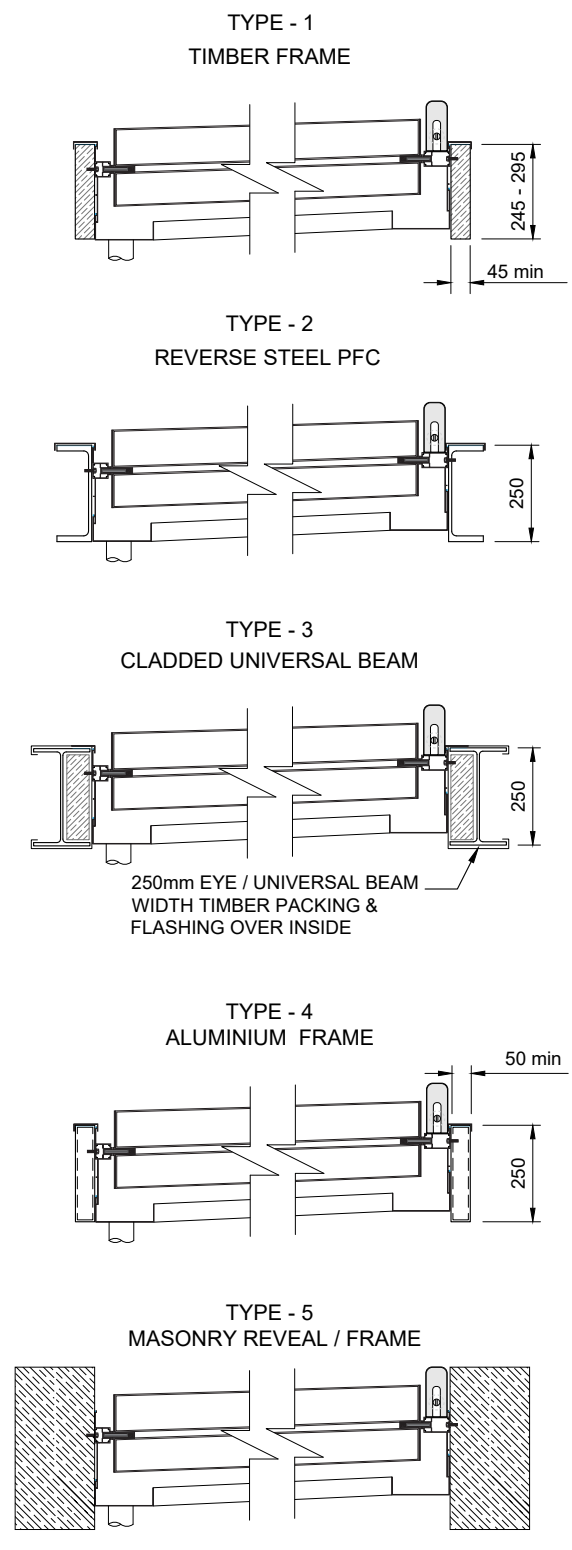

PLEASE NOTE:
IF YOUR PROPOSAL INCLUDES THE CONSTRUCTION OF SUPPORT FRAME, OUR PROPRIETARY ALUMINIUM SUPPORT FRAME OR CUSTOM TIMBER SUPPORT FRAME ARE THE OPTIONS.
ALL MEASUREMENTS ABOVE INDICATE THE MINIMUM SECTION SIZE REQUIRED TO HOUSE THE AEROTECH SYSTEM.

CLIENT DESIGN / MANUFACTURING APPROVAL:

APPROVED
AMEND

REV	DATE	ISSUED FOR APPROVAL	DRN	APPR
A	11.05.16	ISSUED FOR APPROVAL	S.M	D.C

I: _____
PRINT NAME SIGNATURE



Skymax Australia Pty. Ltd.
SYDNEY OFFICE:
2/410 Pittwater Rd
North Manly, NSW 2100 Australia
Mob +61 4418 844 491
T +61 2 8041 6258
Web: skymax.com.au

CLIENT: SPECIFICATIONS BLADES PERPENDICULAR WITH BUILDING	DATE: 29/01/2020	JOB No: -
TITLE: AEROTECH SERIES - LINEAR 275 OPENING LOUVRED ROOF	SCALE: NOT TO SCALE	DRAWING No: AL-195
	DRAWN: SKYMAX	CHECKED: D.CRABB
		ISSUE/REVISION: A