

AEROTECH SERIES - LINEAR 235 MODEL

BLADE SPECIFICATIONS	
BLADE DESIGN	LINEAR
BLADE DIMENSIONS	235mm x 40mm x 3mm
BLADE MATERIAL	6016 EXTRUDED ALUMINIUM
BLADE FINISH	POWDER COATED
BLADE CENTRES	223mm
BLADE OPENING	183mm
GUTTER SPECIFICATIONS	
GUTTER DESIGN	SQUARE EDGE LOW-STREAMLINE
GUTTER DIMENSIONS	155mm x 45mm x 2mm
GUTTER MATERIAL	6061 EXTRUDED ALUMINIUM
GUTTER FINISH	POWDER COATED
PIVOT SPECIFICATIONS	
PIVOT TRACK	68mm x 40mm x 3mm
PIVOT TRACK MATERIAL	6061 EXTRUDED ALUMINIUM
PIVOT TRACK FINISH	POWDER COATED
DRIVE ARM SPECIFICATIONS	
DRIVE-ARM	25mm x 10mm
DRIVE-ARM MATERIAL	6061 EXTRUDED ALUMINIUM
DRIVE-ARM FINISH	POWDER COATED
PARTS AND CONNECTOR SPECIFICATIONS	
PIN SET	8mm DIA 316 MARINE GRADE STAINLESS STEEL
SPRING SET	316 MARINE GRADE STAINLESS STEEL
CONNECTOR HOUSING	100% UV STABLE HARDENED NYLON INNER
WEATHER STRIP	PVC STORM INSERTION STRIP
MOTOR & CONTROL SPECIFICATIONS	
MOTOR TYPE	GERMAN MADE LINEAR 240V ACTUATOR
CONTROLS	HARD WIRED OR REMOTE OPERATION
SENSORS	RAIN, WIND & SUN SENSORS

AEROTECH SERIES - LINEAR 235 MODEL - OPENING LOUVRED ROOF SYSTEM

BLADES PARALLEL WITH BUILDING - TRIPLE BAY

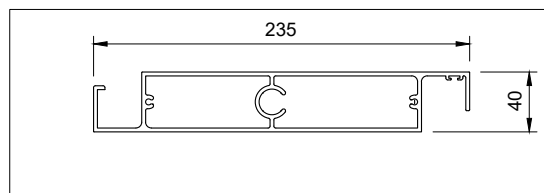
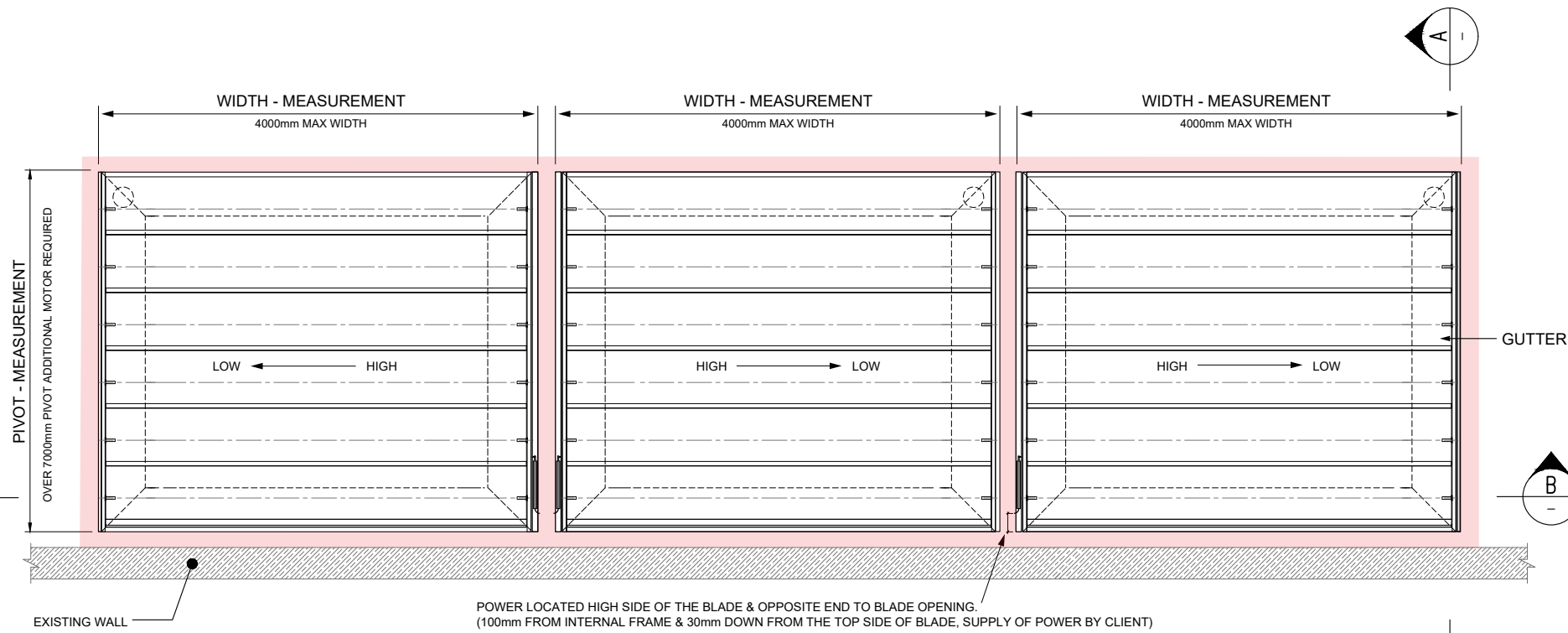
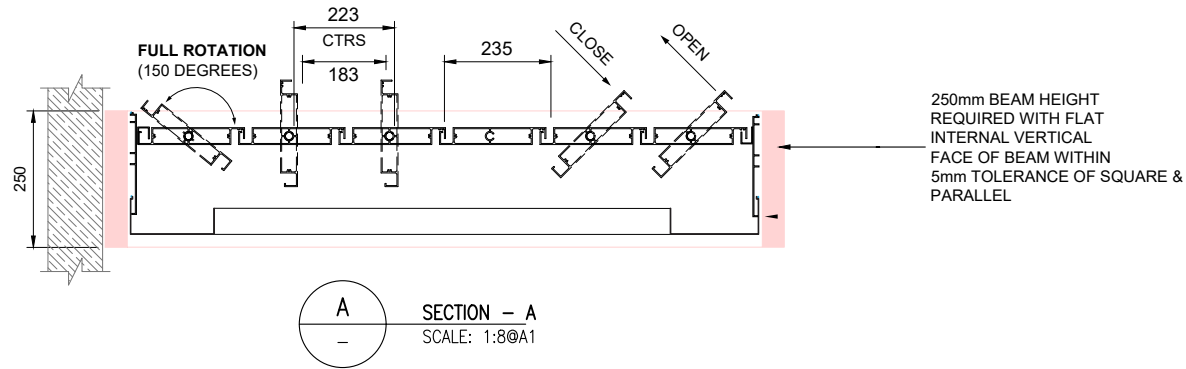

235 LOUVRE BLADE DETAIL
SCALE 1:2 @A1

LEGEND:
THIS INDICATES SUPPORT FRAME BY CLIENT

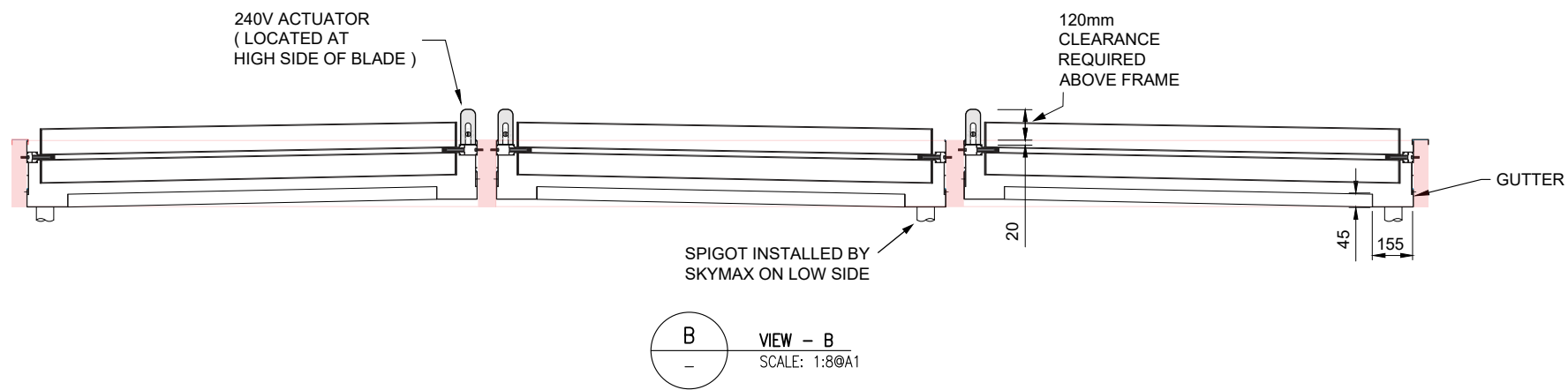
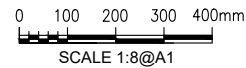

VIEW - B
SCALE: 1:8@A1

SUPPORT FRAME CONSTRUCTED BY CLIENT - DESIGN OPTIONS
(AEROTECH SYSTEM EXCLUDES SUPPORT FRAME)

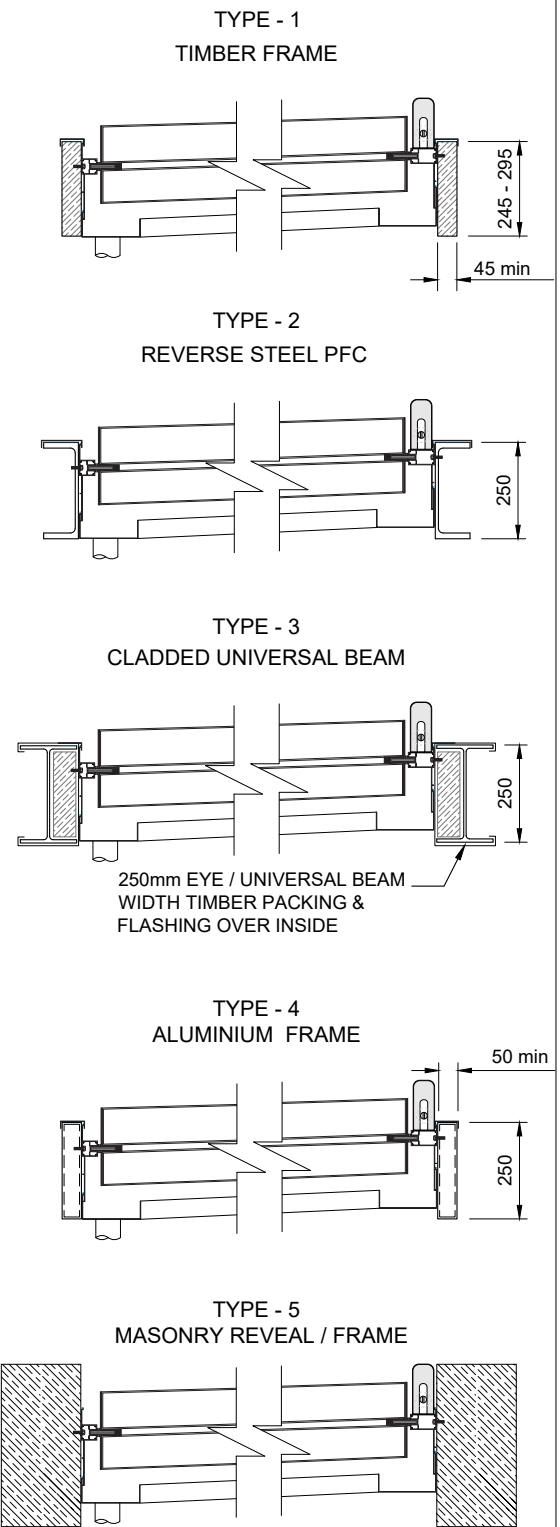

PLEASE NOTE:
IF YOUR PROPOSAL INCLUDES THE CONSTRUCTION OF SUPPORT FRAME, OUR PROPRIETARY ALUMINIUM SUPPORT FRAME OR CUSTOM TIMBER SUPPORT FRAME ARE THE OPTIONS.
ALL MEASUREMENTS ABOVE INDICATE THE MINIMUM SECTION SIZE REQUIRED TO HOUSE THE AEROTECH SYSTEM.

CLIENT DESIGN / MANUFACTURING APPROVAL:

APPROVED
AMEND

REV	DATE	ISSUED FOR APPROVAL	DRN	APPR
A	11.05.16	ISSUED FOR APPROVAL	S.M	D.C



SkyMax Australia Pty. Ltd.
SYDNEY OFFICE:
2/410 Pittwater Rd
North Manly, NSW 2100 Australia
T 1300 929 743
E info@skymax.com.au
W skymax.com.au

CLIENT: SPECIFICATIONS BLADES PARALLEL WITH BUILDING, TRIPLE BAY	DATE: 29/01/2020	JOB No: -
TITLE: AEROTECH SERIES - LINEAR 235 OPENING LOUVRED ROOF	SCALE: NOT TO SCALE	DRAWING No: AL-195
	DRAWN: SKYMAX	CHECKED: D.CRABB
		ISSUE/REVISION: A