

AEROTECH LINEAR 215 MODEL ORDER SHEET

ROOF

1. WIDTH - INTERNAL FRAME	
2. PIVOT - INTERNAL FRAME	
3. BLADE FINISH	
4. GUTTER FINISH	
5. SPIGOT SIZE	
6. SPIGOT TYPE	

CONTROLS REQUIRED

7. SWITCH TYPE	
8. REMOTE TYPE	
9. RECEIVER TYPE	
10. WIND SENSOR TYPE	
11. RAIN SENSOR TYPE	
12. -	
13. -	

FRAME DETAILS

14. FRAME BY OTHERS	
15. FRAME MATERIAL	
16. FRAME DEPTH	
17. FRAME THICKNESS	
18. Alum FRAME REQ IN ORDER (250x50)	
19. FRAME COLOUR	
20. POST REQUIRED	
21. POST SIZE REQUIRED	
22. POST HEIGHT REQUIRED	
23. POST BASE PLATE DETAIL	
24. POST FOUNDATION TYPE	
25. -	
26. -	
27. -	
28. -	
29. -	
30. -	

**AEROTECH LINEAR 215 - OPENING LOUVRED ROOF SPECIFICATION
BLADES INSTALLED PERPENDICULAR TO BUILDING - ORDER SHEET**

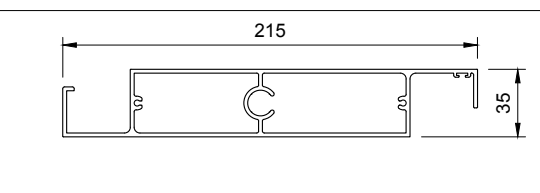
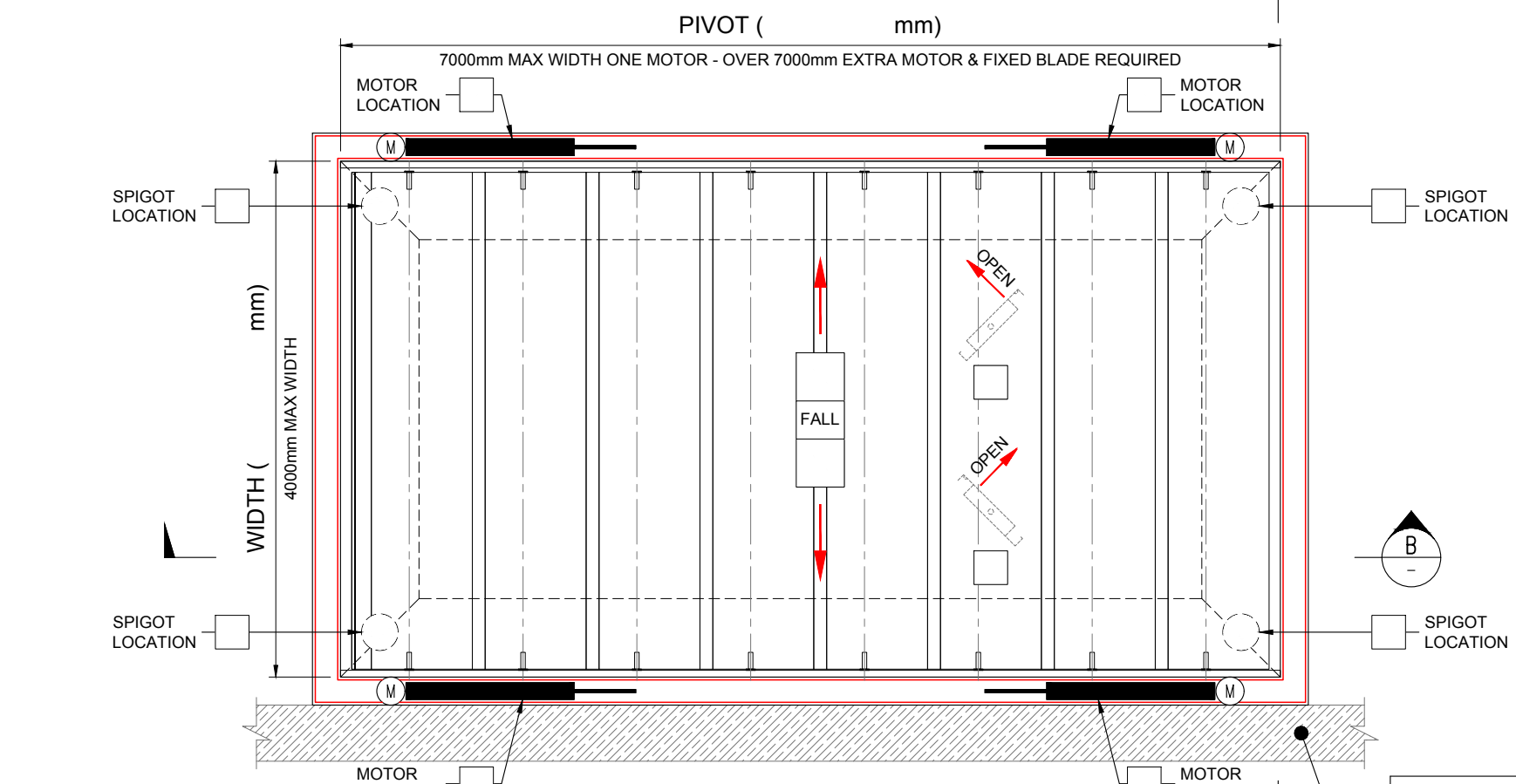
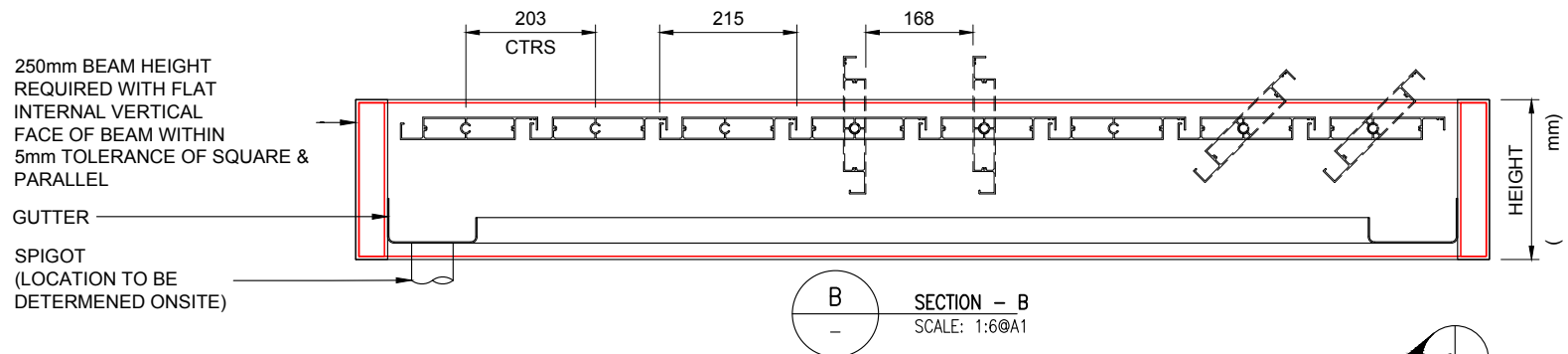

215 LOUVRE BLADE DETAIL
SCALE 1:2 @A1

LEGEND:
THIS INDICATES SUPPORT FRAME (BY OTHERS)

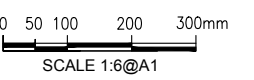

SCALE 1:6 @A1

I: _____
PRINT NAME SIGNATURE

APPROVED

AMEND

REV	DATE	ISSUED FOR APPROVAL	DRN	APPR
A	11.05.16	ISSUED FOR APPROVAL	J.P	D.C

VIEW - A
SCALE: 1:6 @A1

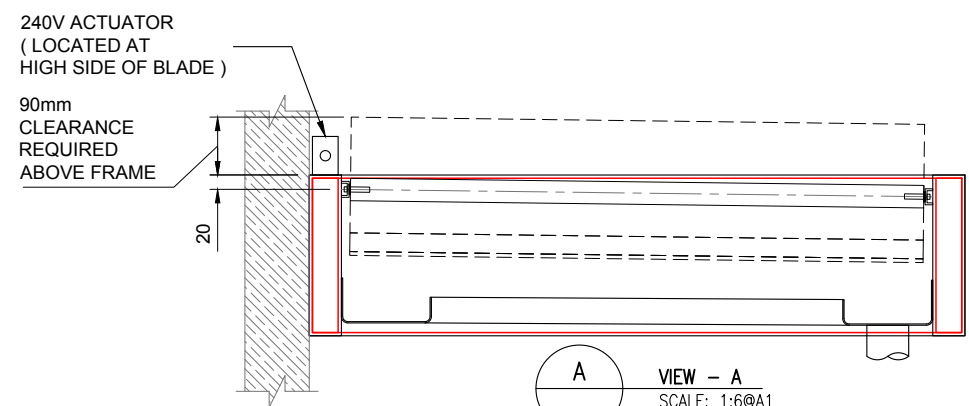

EXISTING WALL	
BRICK	
CONCRETE	
TIMBER	
FC SHEET	
STEEL	
OTHER	

NOTE:
PLEASE MARK WALL TYPE, IF VARIES, THAN NOTE ON DRAWING

SUPPORT FRAME DESIGN OPTIONS
(AEROTECH SYSTEM EXCLUDES SUPPORT FRAME)

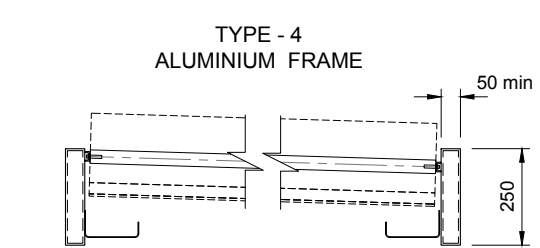
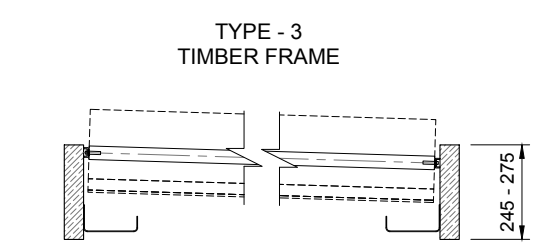
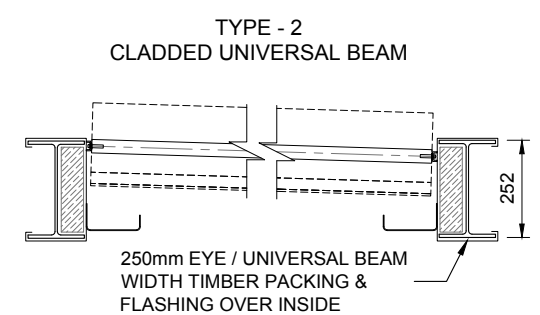
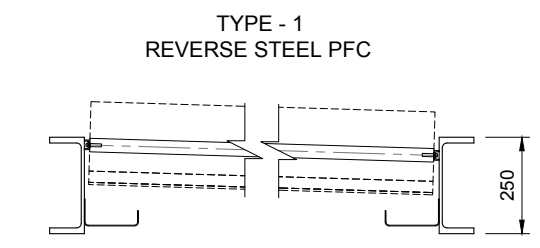

PLEASE NOTE:
SKYMAX CAN CONSTRUCT TYPE 4 FRAME AS OPTIONAL

CLIENT DESIGN / MANUFACTURING APPROVAL:



Skymax Australia Pty. Ltd.
SYDNEY OFFICE:
2/410 Pittwater Rd
North Manly, NSW 2100 Australia
Mob +61 4418 844 491
T +61 2 8041 6258
Web: skymax.com.au

CLIENT: SPECIFICATIONS
BLADES PERPENDICULAR
TO BUILDING - ORDER SHEET

TITLE: AEROTECH LINEAR 215
OPENING LOUVRED ROOF

DATE: 11/05/2016

SCALE: 1:6 @A1

DRAWN: J.P

CHECKED: D.CRABB

JOB No: -

DRAWING No: OS - 05

ISSUE/REVISION: A

ALL DRAWINGS AND TECHNICAL INFORMATION CONTAINED ON THIS PAGE REMAIN THE SOLE PROPERTY OF SKYMAX SERVICES Pty. Ltd. NO INFORMATION CONTAINED ON THIS PAGE IS TO BE REPRODUCED IN PART / IN FULL WITHOUT THE PRIOR CONSENT OF SKYMAX Pty Ltd. SERVICES WRITTEN DIMENSION TO TAKE OVER SCALING. ALL DIMENSION ARE TO BE CONFIRMED ON SITE PRIOR TO FABRICATION / INSTALLATION